

Your custom gearbox as standard

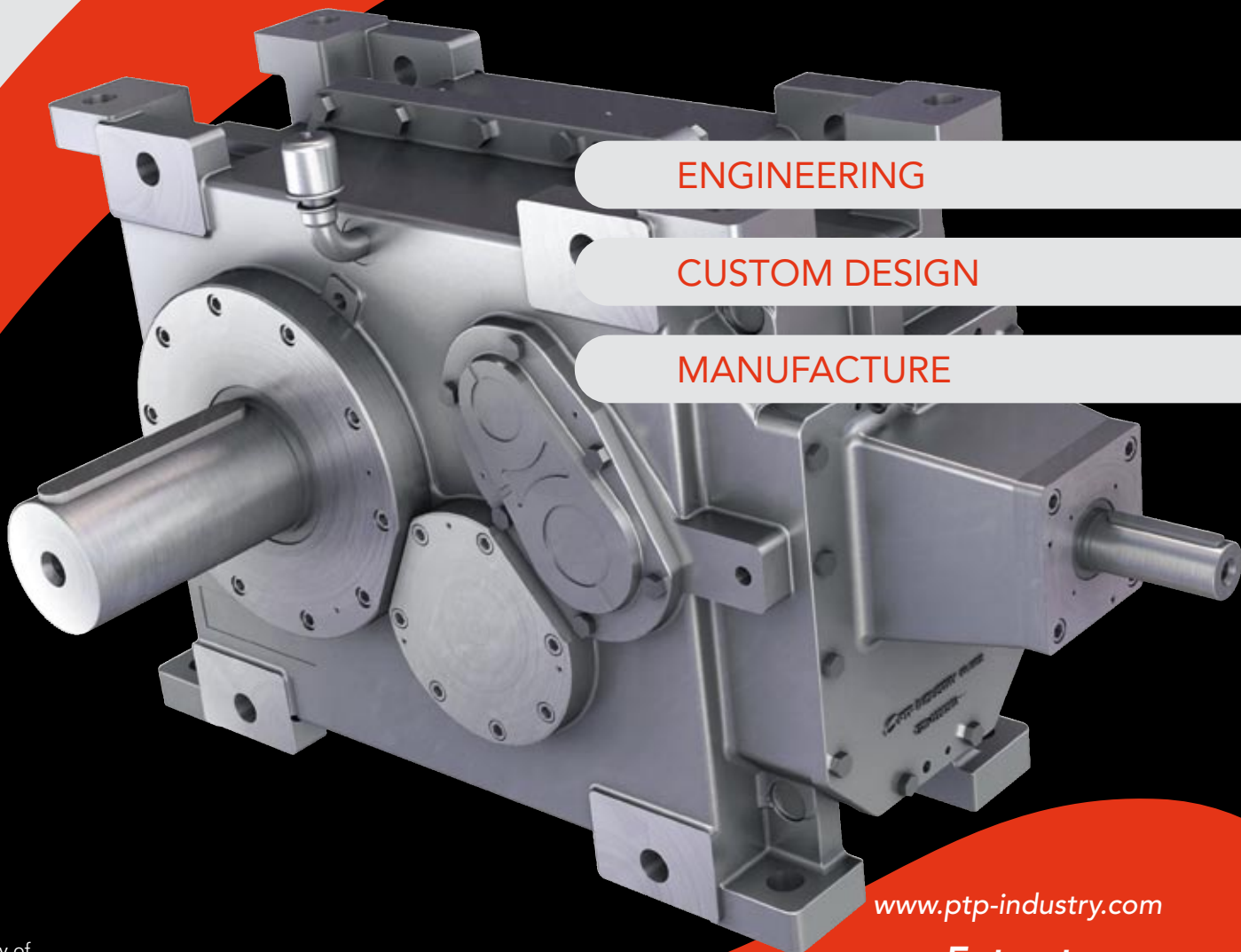

ENGINEERING

CUSTOM DESIGN

MANUFACTURE

an activity of

PTP INDUSTRY
All Power Transmission Products know-how

www.ptp-industry.com

**Entrust your
projects to us!**

For more than 50 years our engineers and technicians in Raon l'Etape have been designing global power transmission solutions. This substantial experience means that we can provide the gearboxes that meet your needs: customization with standard components.



Our Gearbox Capacities

- Power: 0.12 to 7000 kW
- Torque: 2 Nm to 600,000 Nm
- Ratios: 1 to 1250
LS shaft Ø: 25 to 340 mm
Hollow LS shaft Ø: 30 to 360 mm
- 1 to 5-stage gearboxes
- Multiple outputs gearboxes
- Weight: 10 to 10,000 kg
- Cast iron and steel or aluminium housings
- Gearboxes for acid environments
- Customized bed plates
- Customized fastenings

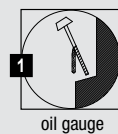

oil gauge



breather



oil level indicator

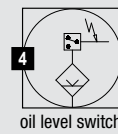

oil level switch

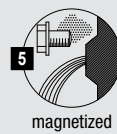

magnetized drain plug



drain valve with union

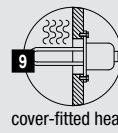

cover-fitted heater



filler cap



dust-proof breather



regreasable labyrinth seal

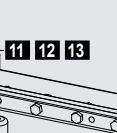

fan

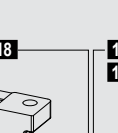

nipple for vibration detector

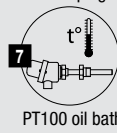

PT100 oil bath thermal sensor

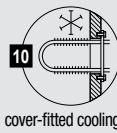

cover-fitted cooling coil



humidity-proof breather

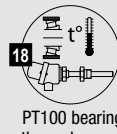

PT100 bearing thermal sensor

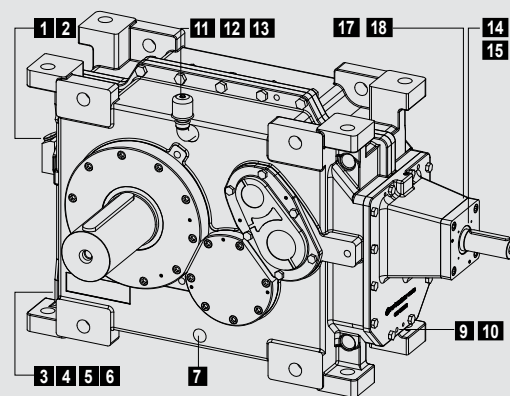

Designer and manufacturer of couplings, pulleys, Flotax and the Hydro-flow range, PTP INDUSTRY provides complete solutions to all your power transmission requirements around the gearbox, whatever the environment (ATEX, etc.). Non-standard dimensions on request. Choice of materials. Special design.



Transmission product solutions

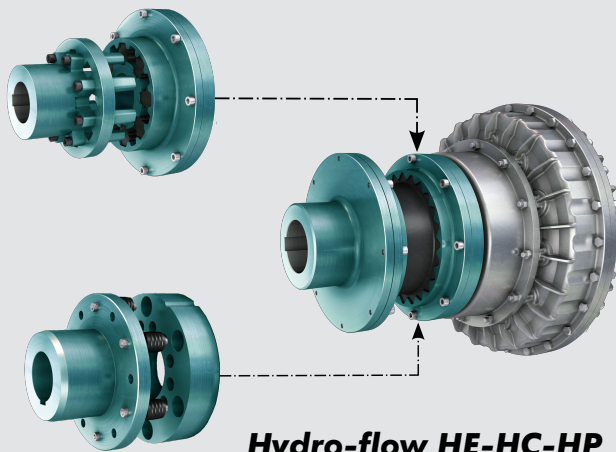

Hydro-flow HE-HC-HP

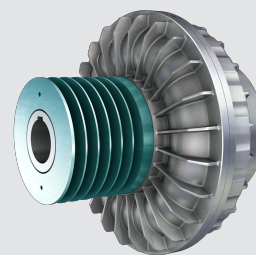

Hydro-flow HV

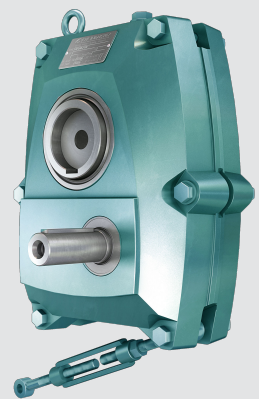

FLOTAX®

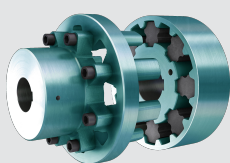

TEX-O-flex

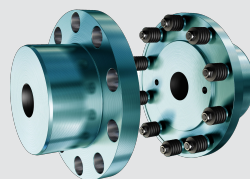

PENCOflex

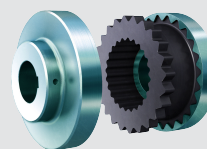

SR-flex®

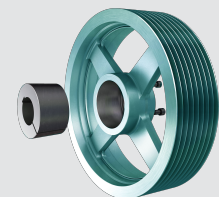

Magic-grip-T®

Since 1945, our Raon l'Étape factory has been known and recognized for its gearbox capabilities, first as a manufacturer, then in recent years with its all-make repair and maintenance facility.



Gearbox know-how and maintenance

As manufacturer, our design office can bring you a solution, using our products or our partners', modify or repair a gearbox.

- **Design/Rebuilding** of gearboxes
- **Manufacturing** of all mechanical components including housings
- **Maintenance/Repair** of all generations of **Hansen** gearboxes
- **Maintenance/Repair** of **all makes** of gearboxes

All our gearboxes manufactured, modified or repaired in our factory carry our **manufacturer's guarantee**.

On-site assessment

Gearboxes and control units

- Bearings and gear sets
 - Temperature monitoring
 - Oil-tightness and lubrication
 - Vibration analysis and noise level
- LS and HS shaft connecting equipments
- Review of the drive kinematics (dimensioning, fastenings, fittings, alignment, wear, etc.)

Workshop proficiency

Gearboxes and drive units

- Evaluation of bearing and gear sets damages
- Disassembly, cleaning and check of mechanical parts
- Review of the drive kinematics
- Reassembly, testing
- Paint

Enhance your equipment through our know-how



EXPERT DIAGNOSIS

MAINTENANCE

REPAIR/REBUILDING

ASSISTANCE

an activity of

 **PTP INDUSTRY**
All Power Transmission Products know-how

www.ptp-industry.com

**Entrust your
projects to us!**

Global power transmission solutions

For more than 70 years, under the names *SIT Texrope*, *Hansen-SIT*, *Brook Hansen*, *Rexnord* and today **PTP INDUSTRY**, our company has been known and recognized for its substantial experience in the selection, assessment, manufacture and maintenance of geared reducers and multipliers as well as other power transmission equipments and components.



Our Raon l'Étape site



PTP INDUSTRY • La Belle Orge • F-88110 Raon L'Étape

Tel.: +33 (0)3 29 52 62 72

Fax: +33 (0)3 29 41 92 03

E-mail : contact@ptp-industry.com

www.ptp-industry.com

PTP INDUSTRY S.A.S. • RCS Épinal B 542 110 556 • APE 24.51 Z